



Cast Marble Solutions for Your Showers



60" x 30"-8" Trench Drain LH or RH Shower Base SB60x30-8TD-XH-LC

Est. Weight: 160 lbs (72 kg) IMI LiteCast™

TECHNICAL SPECIFICATIONS

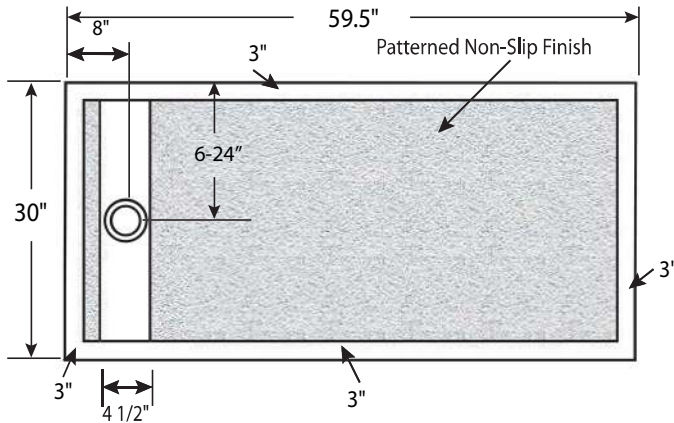

Side View of Curb

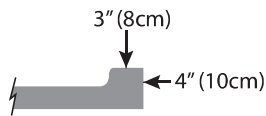

Drain Cover

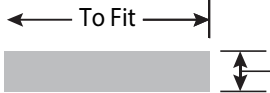

Note: pan dimensions vary +/- 1/8"

Drain Details: (U.S.)

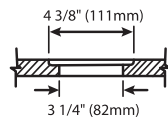

Flange Details: (U.S.)

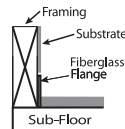

Front View - Left Drain

Fiberglass flange: Back and Sides

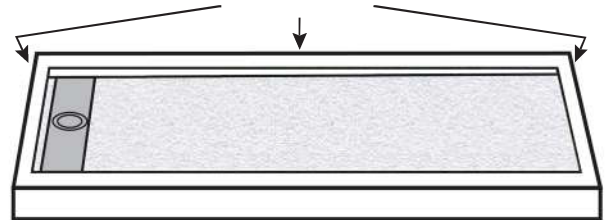

Front View - Right Drain

Fiberglass flange: Back and Sides

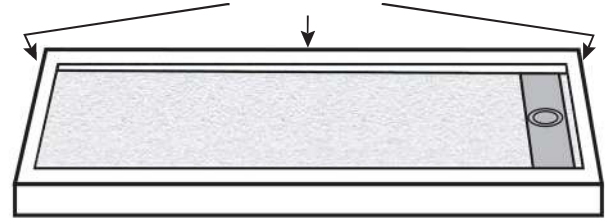

Standard Features:

- Solid one-piece construction
- Pre-leveled - rests on subfloor
- Mold and mildew resistant
- Bacteria resistant
- Textured non-slip finish
- Abrasion resistant gelcoat surface
- Stainless steel trench drain cover

Specifications:

- Size: 59.5" x 30"
- Drain Location: Center of drain measures 8" from side of pan
6-24" from backwall
- Flange: Fiberglass
- Trench: 4 1/2" width



Solvent Weld type fitting similar to Oatey Part No. 42097



Compression type "No-Caulk" fitting similar to Oatey Part No. 42099

Note: Base dimensions vary by +/- 1/8"

* Also available in IMI ProCast™

Our products comply with one or more of the following: IAPMO, ANSI, HUD, NAHB, NHQ

22 42 23 (Div 22)

Revised: 2020.01.21

© 2019 Copyright International Marble Industries, Inc.

