

SB60x32-4TD-xH-SC

inches

60 X 32 SOLID SURFACE SHOWER BASE WITH RH OR LH TRENCH DRAIN
IMI SOLIDCAST™

Exterior Dimensions: 59 3/4" x 32"

Note: Base dimensions may vary +/- 1/8"

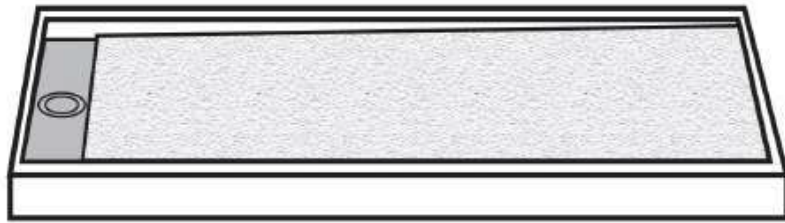

FEATURES

- Solid one-piece construction, nonporous through body
- Integral flange
- Pre-leveled, rests on subfloor
- Solid surface construction, contains minimum 60% solid particle aggregate aluminum hydroxide
- 40% acrylic modified polyester resin

STANDARDS AND RATINGS

- Typical CSI Code: 22 42 23 (Div 22)
- ANSI
- ASTM (Fire Rating)
- MAS Certified Green
- Slip-resistance: SCoF = 0.6+, wet; DCoF = 0.42+
- Breaking strength: 250 lbs. minimum

*See terms and conditions for details.

Material to be stacked on pallets.

COLOR & TRIM OPTIONS

Standard Color	Code
White	SW

Additional custom colors available.



Solid Surface Solutions



SB60x32-4TD-xH-SC

60 X 32 SOLID SURFACE SHOWER BASE WITH RH OR LH TRENCH DRAIN
IMI SOLIDCAST™

Note: Base dimensions may vary +/- 1/8"

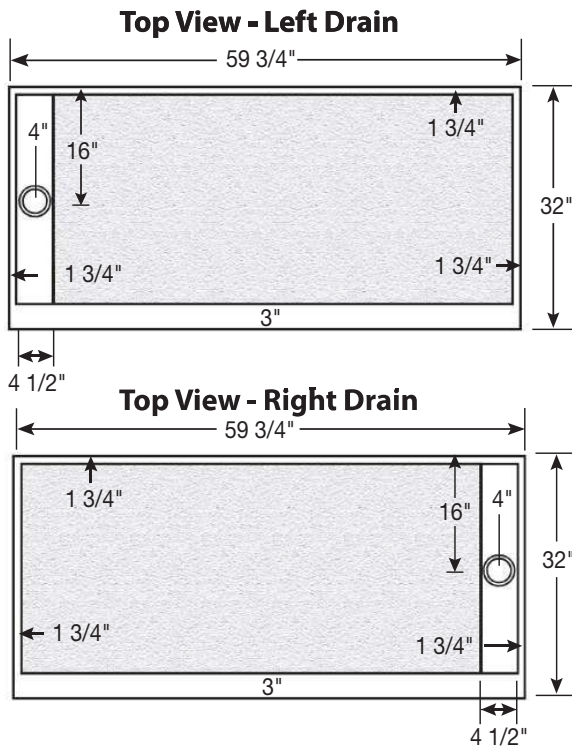

Side View of Curb

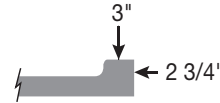

Drain Cover



Drain Details: (U.S.)

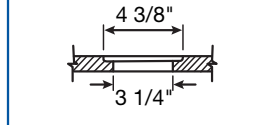

Flange Details: (U.S.)

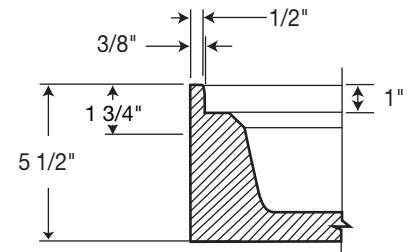



FEATURES Dimensional Tolerance ± 1/4". Dimensions needed for site preparation should be measured from the unit. American Bath Group assumes no responsibility for preparatory work.

Type and Model #	Material	Shower Base	Pieces
Shower Base #SB60x32-4TD-xH-SC	Cast Solid Surface	Anti-Slip/Textured Finish	1

DIMENSIONS

Specifications	inches
Shower Base Depth:	32
Shower Base Width:	59 3/4
Curb Height:	2 3/4
Curb Width:	3

SUGGESTED DRAINS

Image	Description
	Solvent Weld type fitting similar to Oatey Part No. 42097
	Compression type "No-Caulk" fitting similar to Oatey Part No. 42099