

# SB60x42-SSB-LC

60 X 42 SHOWER BASE WITH CENTER DRAIN

IMI LITECAST™

Note: Base dimensions may vary +/- 1/4"

\* Also available in IMI ProCast™



Material to be crated and stacked on pallets.



Cast Marble Solutions

## COLOR & TRIM OPTIONS

Standard Color	Code
White	SW

Optional Color	Code
Cream	SC
Ivory	SI
Warm White	WW



## FEATURES

- **Shower base size:** 60" x 42"
- **Curb size:** 3" x 4"
- **Construction:**
  - \* Solid one piece
  - \* Pre-leveled
  - \* Rests on the subfloor
  - \* Grout-free
  - \* Non-porous
  - \* Water & Leak-proof
- **Resistant to:**
  - \* Bacteria
  - \* Mold and mildew
  - \* Stains (easy to clean)
- **Flange:** Industrial composite (attached in our factory)

## STANDARDS AND RATINGS

- Typical CSI Code: 22 42 23 (Div 22)
- Complies with ANSI Z124 Test
- Complies with ASTM F 462 (Anti-slip test), Our lowest value read was 0.07, test requires 0.04
- MAS Certified Green
- ASTM (Fire rating)

Code compliant when fully equipped and installed according to guidelines.



**Top View**

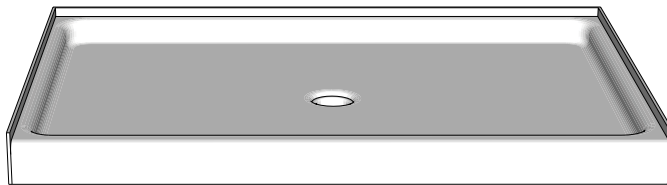
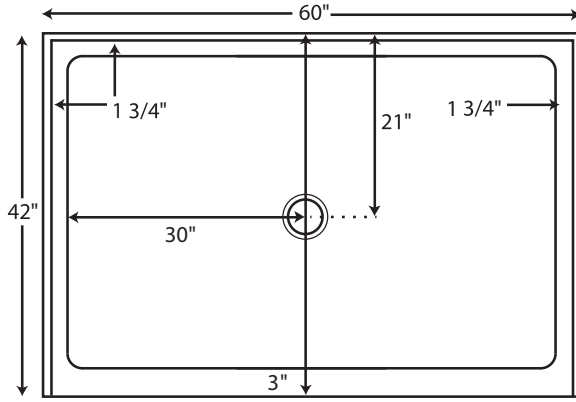

**Flange Details: (U.S.)**

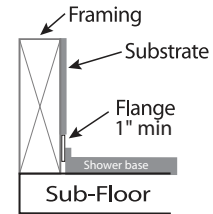

**Drain Details: (U.S.)**

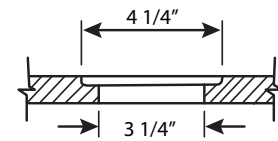

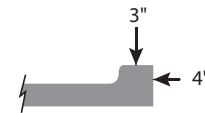

**Side View of Curb**



**FEATURES** Dimensional Tolerance  $\pm 1/4"$ . Dimensions needed for site preparation should be measured from the unit. American Bath Group assumes no responsibility for preparatory work.

Type and Model #	Material	Shower Base	Pieces
Shower Base #SB60x42-SSB-LC	Cast Marble	Anti-Slip/Textured Finish	1

**SUGGESTED DRAINS**

Image	Description
	Solvent Weld type fitting similar to Oatey Part No. 42097
	Compression type "No-Caulk" fitting similar to Oatey Part No. 42099

Drains are not sold by IMI

Rev. 03.2024